

INNOLUX DISPLAY CORPORATION

LCD MODULE

SPECIFICATION

Customer: _____
Model Name: AT070TN84 V.1
SPEC NO.: A070-84-TT-11
Date: 2008/07/21
Version: 01

- Preliminary Specification
 Final Specification

For Customer's Acceptance

| Approved by | Comment |
|-------------|---------|
| | |

| Approved by | Reviewed by | Prepared by |
|-------------|-------------|-------------|
| Joe Lin | Hans Chen | Kevin Chen |
| 2008/07/31 | 2008/07/31 | 2008/07/31 |

Record of Revision

| Version | Revise Date | Page | Content |
|--------------|-------------|------|------------------|
| Pre-spec. 01 | 2008/07/21 | | Initial release. |

Contents

| | |
|---|----|
| 1. General Specifications | 1 |
| 2. Pin Assignment | 2 |
| 2.1. TFT LCD Panel Driving Section | 2 |
| 2.2. Backlight Unit Section | 5 |
| 3. Operation Specifications | 6 |
| 3.1. Absolute Maximum Ratings | 6 |
| 3.2. Typical Operation Conditions | 7 |
| 3.2.1. Current Consumption | 8 |
| 3.2.2. Backlight Driving Conditions | 8 |
| 3.3. Power Sequence | 9 |
| 3.4. Timing Characteristics | 10 |
| 3.4.1. Timing Conditions | 10 |
| 3.4.2. Timing Diagram | 12 |
| 4. Optical Specifications | 19 |
| 5. Reliability Test Items | 23 |
| 6. General Precautions | 24 |
| 6.1. Safety | 24 |
| 6.2. Handling | 24 |
| 6.3. Static Electricity | 24 |
| 6.4. Storage | 24 |
| 6.5. Cleaning | 24 |
| 7. Mechanical Drawing | 25 |
| 8. Package Drawing | 26 |
| 8.1. Packaging Material Table | 26 |
| 8.2. Packaging Quantity | 26 |
| 8.3. Packaging Drawing | 27 |

1. General Specifications

| No. | Item | Specification | Remark |
|-----|-----------------------------|------------------------------|--------|
| 1 | LCD size | 7.0 inch(Diagonal) | |
| 2 | Driver element | a-Si TFT active matrix | |
| 3 | Resolution | 800 × 3(RGB) × 480 | |
| 4 | Display mode | Normally white, Transmissive | |
| 5 | Dot pitch | 0.0635(W) × 0.1905(H) mm | |
| 6 | Active area | 152.4 (W) × 91.44 (H) mm | |
| 7 | Module size | 165(W) × 104(H) × 5.5(D) mm | Note1 |
| 8 | Surface treatment | Anti-Glare | |
| 9 | Color arrangement | RGB-stripe | |
| 10 | Interface | Digital | |
| 11 | Backlight power consumption | (1.782W) (Typ.) | |
| 12 | Panel power consumption | 0.437W (Typ.) | |
| 13 | Weight | TBD | |

Note1: Refer to Mechanical Drawing.

2. Pin Assignment

2.1. TFT LCD Panel Driving Section

FPC Connector is used for the module electronics interface. The recommended model is P-TWO “AF 730L-A2G1T” manufactured by P-TWO.

| Pin No. | Symbol | I/O | Function | Remark |
|---------|------------------|-----|--|----------|
| 1 | POL | I | Polarity selection | |
| 2 | STVD | I/O | Vertical start pulse input when U/D= H | Note 1 |
| 3 | OEV | I | Output enable | |
| 4 | CKV | I | Vertical clock | |
| 5 | STVU | I/O | Vertical start pulse input when U/D= L | Note 1 |
| 6 | GND | P | Power Ground | |
| 7 | EDGSL | I | Select rising edge or falling edge | |
| 8 | DV _{DD} | P | Power Voltage for Digital Circuit | |
| 9 | V9 | I | Gamma voltage level 9 | |
| 10 | V _{GL} | P | Gate OFF voltage | |
| 11 | V2 | I | Gamma voltage level 2 | |
| 12 | V _{GH} | P | Gate ON voltage | |
| 13 | V6 | I | Gamma voltage level 6 | |
| 14 | U/D | I | Up/down selection | Note 1,2 |
| 15 | V _{COM} | I | Common voltage | |
| 16 | GND | P | Power Ground | |
| 17 | AV _{DD} | P | Power Voltage for Analog Circuit | |
| 18 | V14 | I | Gamma voltage level 14 | |
| 19 | V11 | I | Gamma voltage level 11 | |

版權屬於群創所有，禁止任何未經授權的使用

| | | | | |
|----|------------------|-----|--|--------|
| 20 | V8 | I | Gamma voltage level 8 | |
| 21 | V5 | I | Gamma voltage level 5 | |
| 22 | V3 | I | Gamma voltage level 3 | |
| 23 | GND | P | Power Ground | |
| 24 | R5 | I | Red data(MSB) | |
| 25 | R4 | I | Red data | |
| 26 | R3 | I | Red data | |
| 27 | R2 | I | Red data | |
| 28 | R1 | I | Red data | |
| 29 | R0 | I | Red data(LSB) | |
| 30 | GND | P | Power Ground | |
| 31 | GND | P | Power Ground | |
| 32 | G5 | I | Green data(MSB) | |
| 33 | G4 | I | Green data | |
| 34 | G3 | I | Green data | |
| 35 | G2 | I | Green data | |
| 36 | G1 | I | Green data | |
| 37 | G0 | I | Green data(LSB) | |
| 38 | STHL | I/O | Horizontal start pulse input when R/L = L | Note 1 |
| 39 | REV | I | Control signal are inverted or not | Note3 |
| 40 | GND | I | Power Ground | |
| 41 | DCLK | I | Sample clock | |
| 42 | DV _{DD} | P | Power Voltage for Digital Circuit | |
| 43 | STHR | I/O | Horizontal start pulse input when R/L =H | Note 1 |
| 44 | LD | I | Latches the polarity of outputs and Switches the new data to outputs | |

| | | | | |
|----|------------------|---|----------------------------------|----------|
| 45 | B5 | I | Blue data (MSB) | |
| 46 | B4 | I | Blue data | |
| 47 | B3 | I | Blue data | |
| 48 | B2 | I | Blue data | |
| 49 | B1 | I | Blue data | |
| 50 | B0 | I | Blue data (LSB) | |
| 51 | R/L | I | Right/ left selection | Note 1,2 |
| 52 | V1 | I | Gamma voltage level 1 | |
| 53 | V4 | I | Gamma voltage level 4 | |
| 54 | V7 | I | Gamma voltage level 7 | |
| 55 | V10 | I | Gamma voltage level 10 | |
| 56 | V12 | I | Gamma voltage level 12 | |
| 57 | V13 | I | Gamma voltage level 13 | |
| 58 | AV _{DD} | P | Power Voltage for Analog Circuit | |
| 59 | GND | P | Power Ground | |
| 60 | V _{COM} | I | Common voltage | |

I: input, O: output, P: Power

Note 1: Selection of scanning mode

| Setting of scan control input | | IN/OUT state for start pulse | | | | Scanning direction |
|-------------------------------|------------------|------------------------------|------|------|------|---------------------------|
| U/D | R/L | STVD | STVU | STHR | STHL | |
| GND | DV _{DD} | O | I | I | O | Up to down, left to right |
| DV _{DD} | GND | I | O | O | I | Down to up, right to left |
| GND | GND | O | I | O | I | Up to down, right to left |
| DV _{DD} | DV _{DD} | I | O | I | O | Down to up, left to right |

Note 2: Definition of scanning direction.
Refer to the figure as below:

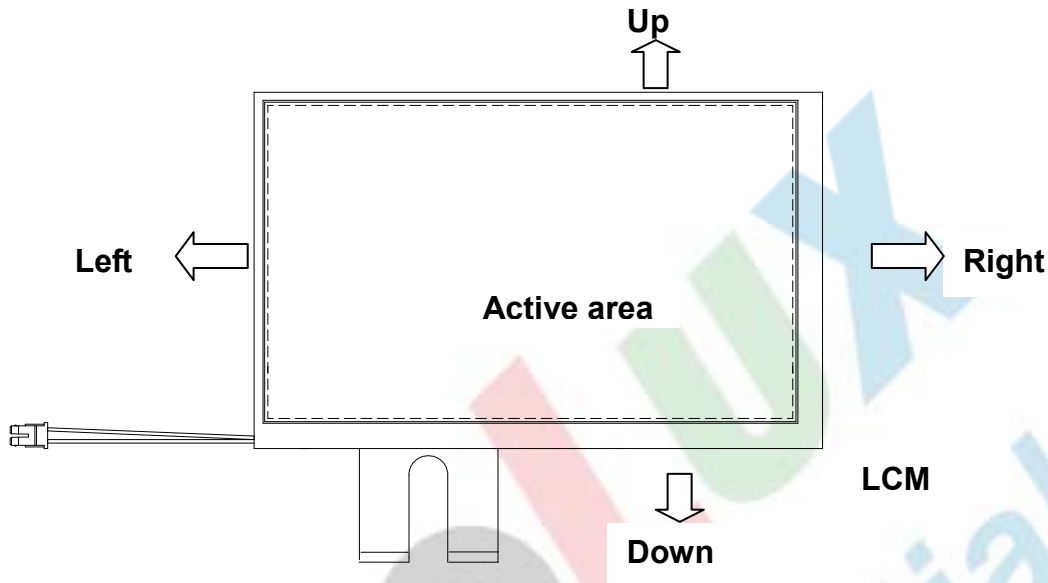

Note 3: When REV="L", it's under normal operation.
When REV="H", these data will be inverted.

2.2. Backlight Unit Section

LED Light Bar Connector is used for the integral backlight system.
The recommended model is BHSR-02VS-1 manufactured by JST.

| Pin No. | Symbol | I/O | Function | Remark |
|---------|-------------------|-----|---------------------------------|--------|
| 1 | V _{LED+} | P | Power for LED backlight anode | Pink |
| 2 | V _{LED-} | P | Power for LED backlight cathode | White |

3. Operation Specifications

3.1. Absolute Maximum Ratings

(Note 2)

| Item | Symbol | Values | | Unit | Remark |
|-----------------------|----------------------------------|----------------------|-----------------------|------|--------------------|
| | | Min. | Max. | | |
| Power voltage | DV _{DD} | -0.5 | 5 | V | |
| | AV _{DD} | -0.5 | 13.5 | V | |
| | V _{GH} | -0.3 | 20.0 | V | |
| | V _{GL} | -13.0 | 0.3 | V | |
| | V _{GH} -V _{GL} | - | 33.0 | V | |
| Input signal voltage | V1~V7 | 0.4 AV _{DD} | AV _{DD} +0.3 | V | Note 1 |
| | V8~V14 | -0.3 | 0.6AV _{DD} | V | |
| Operation Temperature | T _{OP} | -30 | 85 | °C | |
| Storage Temperature | T _{ST} | -30 | 85 | °C | |
| LED Reverse Voltage | V _r | - | 1.2 | V | Each LED Note 3 |
| LED Forward Current | I _F | - | 25 | mA | Each LED |

Note 1: AV_{DD}-0.1 ≥ V1 ≥ V2 ≥ V3 ≥ V4 ≥ V5 ≥ V6 ≥ V7,
V8 ≥ V9 ≥ V10 ≥ V11 ≥ V12 ≥ V13 ≥ V14 ≥ AV_{SS}+0.1.

Note 2: The absolute maximum rating values of this product are not allowed to be exceeded at any times. A module should be used with any of the absolute maximum ratings exceeded, the characteristics of the module may not be recovered, or in an extreme condition, the module may be permanently destroyed.

Note 3: V_r Conditions: Zener Diode 20mA

3.2. Typical Operation Conditions

(Note 1)

| Item | Symbol | Values | | | Unit | Remark |
|--------------------------|------------------|----------------------|------|-----------------------|------|------------------|
| | | Min. | Typ. | Max. | | |
| Power voltage | DV _{DD} | 3.0 | 3.3 | 3.6 | V | Note 2 |
| | AV _{DD} | 10.2 | 10.4 | 10.6 | V | |
| | V _{GH} | 15.3 | 16.0 | 16.7 | V | |
| | V _{GL} | -7.7 | -7.0 | -6.3 | V | |
| Input signal voltage | V _{COM} | - | 4.1 | - | V | (V1+V14)/2 =5.2V |
| | V1~V7 | 0.4 AV _{DD} | - | AV _{DD} -0.1 | V | |
| | V8~V14 | 0.1 | - | 0.6 AV _{DD} | V | |
| Input logic high voltage | V _{IH} | 0.7 DV _{DD} | - | DV _{DD} | V | Note 3 |
| Input logic low voltage | V _{IL} | 0 | - | 0.3 DV _{DD} | V | |

Note 1: Be sure to apply DV_{DD} and V_{GL} to the LCD first, and then apply V_{GH}.

Note 2: DV_{DD} setting should match the signals output voltage (refer to Note 3) of customer's system board.

Note 3: POL, STVD, OEV, CKV, STVU, EDGSL, U/D, STHL, REV, DCLK, STHR, LD, R/L, R0~R5, G0~G5, B0~B5.

3.2.1. Current Consumption

| Item | Symbol | Values | | | Unit | Remark |
|--------------------|---------------|--------|------|------|------|-------------------|
| | | Min. | Typ. | Max. | | |
| Current for Driver | I_{GH} | - | 0.2 | 0.5 | mA | $V_{GH} = 16.0V$ |
| | I_{GL} | - | 0.2 | 1.0 | mA | $V_{GL} = -7.0V$ |
| | IDV_{DD} | - | 5.0 | 10.0 | mA | $DV_{DD} = 3.3V$ |
| | $I_{AV_{DD}}$ | - | 40.0 | 50.0 | mA | $AV_{DD} = 10.4V$ |

3.2.2. Backlight Driving Conditions

| Item | Symbol | Values | | | Unit | Remark |
|---------------------------|--------|--------|-------|--------|------|--------|
| | | Min. | Typ. | Max. | | |
| Voltage for LED Backlight | V_L | (9.3) | (9.9) | (10.5) | V | Note1 |
| Current for LED Backlight | I_L | (170) | (180) | (200) | mA | |
| LED life time | - | 20,000 | - | - | Hr | Note 2 |

Note 1: The Voltage for LED Backlight is defined at $T_a=25^{\circ}C$ and $I_L = 180mA$.

Note 2: The “LED life time” is defined as the module brightness decrease to 50% original brightness at $T_a=25^{\circ}C$ and $I_L = 180mA$. The LED lifetime could be decreased if operating I_L is larger than 180 mA.

3.3. Power Sequence

1. Power on:

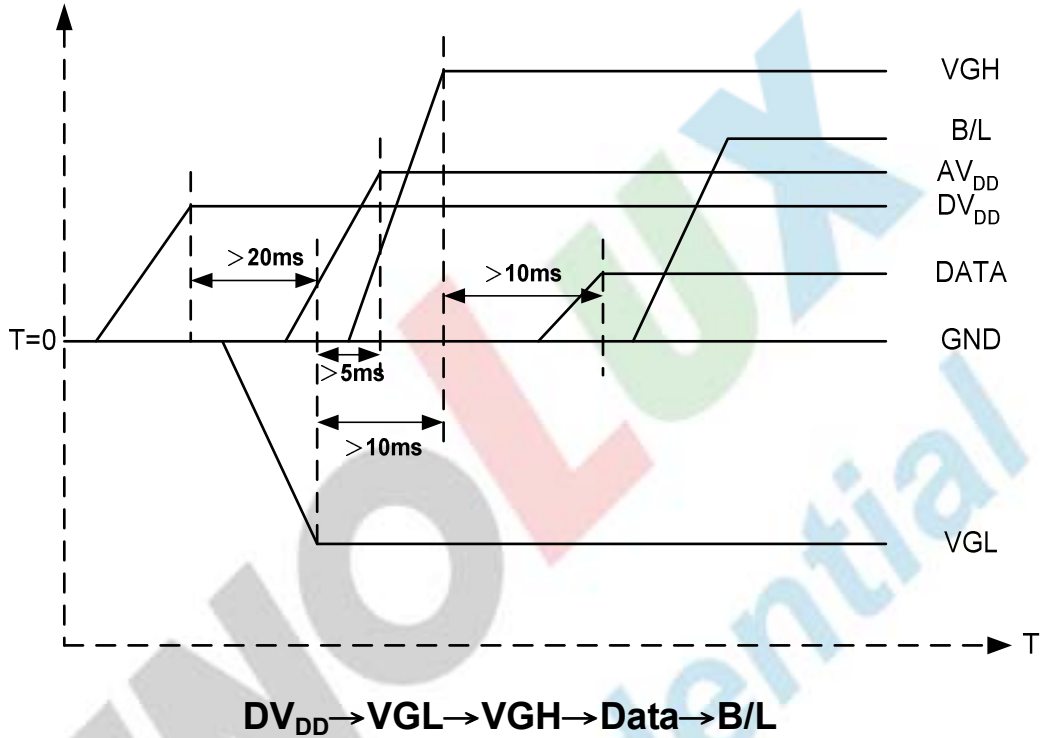

2. Power off:

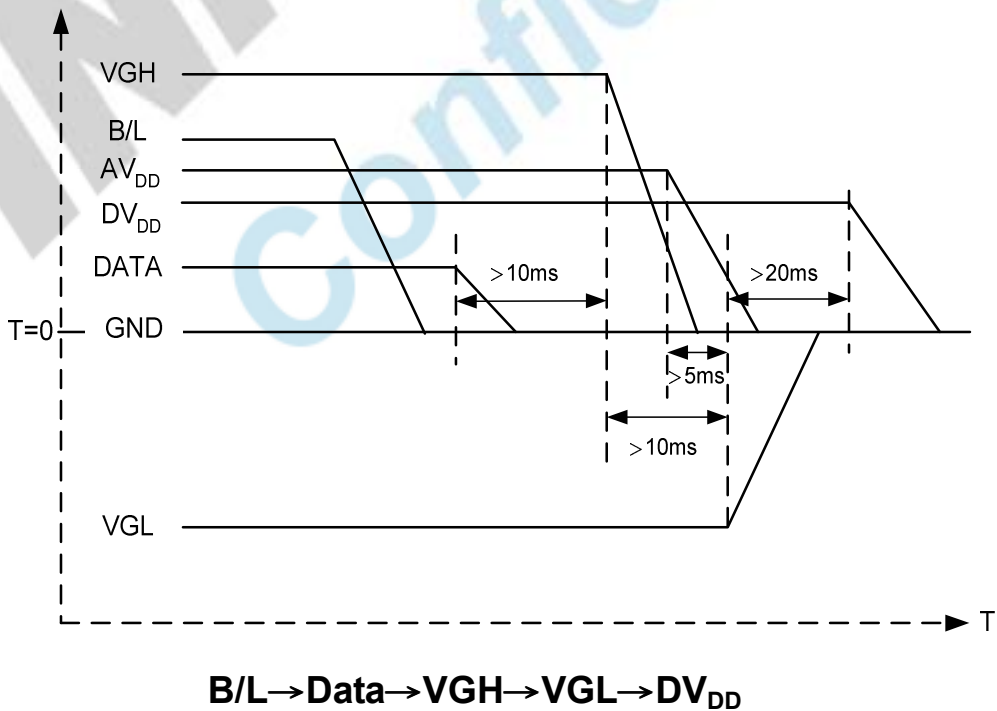

Note: Data include DCLK,POL,OEV,CKV,STVU,STVD,STHL,STHR,LD,R0~R5,G0~G5,B0~B5

版權屬於群創所有。禁止任何未經授權的使用

The copyright belongs to InnoLux. Any unauthorized use is prohibited.

3.4. Timing Characteristics

3.4.1. Timing Conditions

| Item | Symbol | Values | | | Unit | Remark |
|---------------------------------|--------|--------|------|------|------|--------|
| | | Min. | Typ. | Max. | | |
| DCLK frequency | Fdclk | - | 40 | 45 | MHz | |
| DCLK cycle | Tcph | 22 | 25 | - | ns | |
| DCLK pulse width | Tcw | 8 | - | - | ns | |
| Data set-up time | Tsu | 4 | - | - | ns | |
| Data hold time | Thd | 2 | - | - | ns | |
| Time that the last data to LD | Tld | 1 | - | - | Tcph | |
| Pulse width of LD | Twld | 2 | - | - | Tcph | |
| Time that LD to STHL/R | Tlds | 5 | - | - | Tcph | |
| POL set-up time | Tpsu | 6 | - | - | ns | |
| POL hold time | Tphd | 6 | - | - | ns | |
| CKV frequency | Fvclk | - | - | 200 | KHz | |
| CKV rise time | Trck | - | - | 100 | ns | |
| CKV falling time | Tfck | - | - | 100 | ns | |
| CKV pulse width | PWCLK | 500 | - | - | ns | |
| Horizontal display timing range | Tdh | - | 800 | - | Tcph | |
| Horizontal timing range | Th | - | 1056 | - | Tcph | |
| STVU/D setup time | Tsuv | 200 | - | - | ns | |
| STVU/D hold time | Thdv | 300 | - | - | ns | |
| STVU/D delay time | Tdt | - | - | 500 | ns | |
| Driver output delay time | Tdo | - | - | 900 | ns | |

版權屬於群創所有，禁止任何未經授權的使用

The copyright belongs to InnoLux. Any unauthorized use is prohibited.

| | | | | | | |
|---------------------------------|------|-----|-----|------|-----|--|
| Output rise time | Ttlh | - | 500 | 1000 | ns | |
| Output falling time | Tthl | - | 400 | 800 | ns | |
| OEV pulse width | Twcl | 1 | - | - | us | |
| OEV to Driver output delay time | Toe | - | - | 900 | ns | |
| Horizontal lines per field | Tv | 512 | 525 | 610 | Tdh | |
| Vertical display timing range | Tvd | - | 480 | - | Tdh | |

INNOLUX
 Confidential

3.4.2. Timing Diagram

Timing Diagram1 (CHNSL="1", Default)

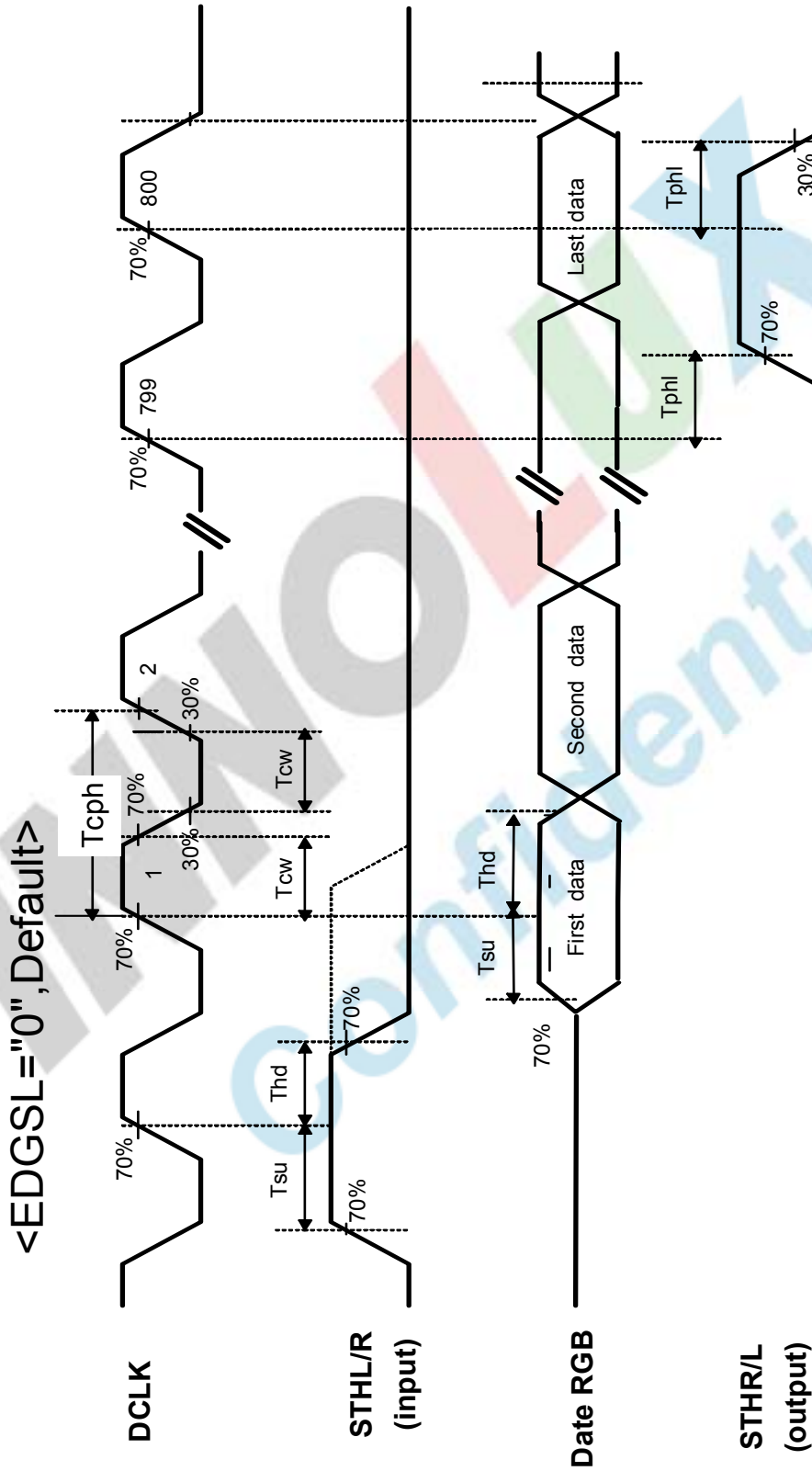

Fig.3-1 operation model 1

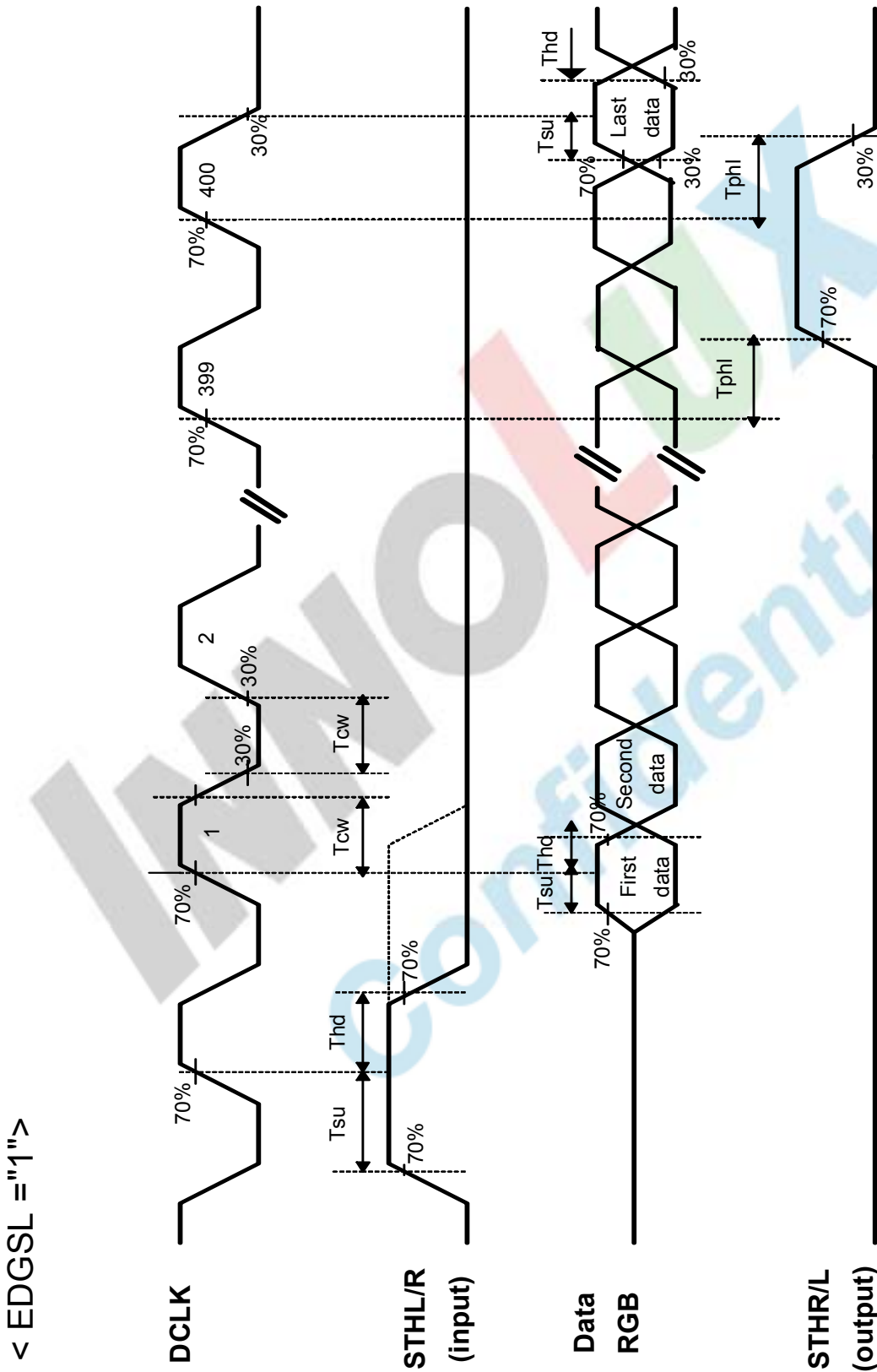

Fig.3-2 operation model 2

版權屬於群創所有，禁止任何未經授權的使用

Timing Diagram 2

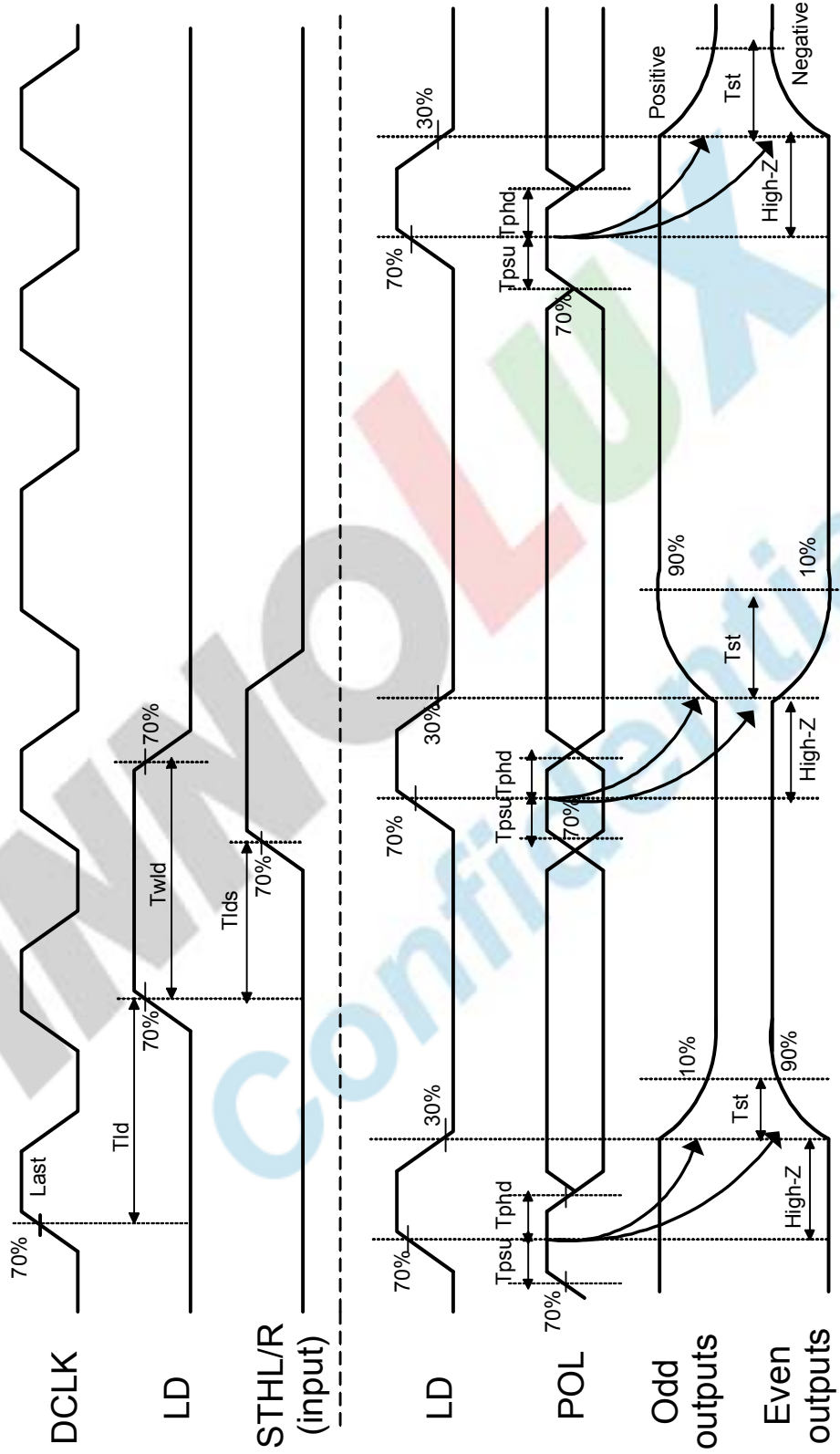

Fig.3-3 Horizontal timing 1

版權屬於群創所有，禁止任何未經授權的使用

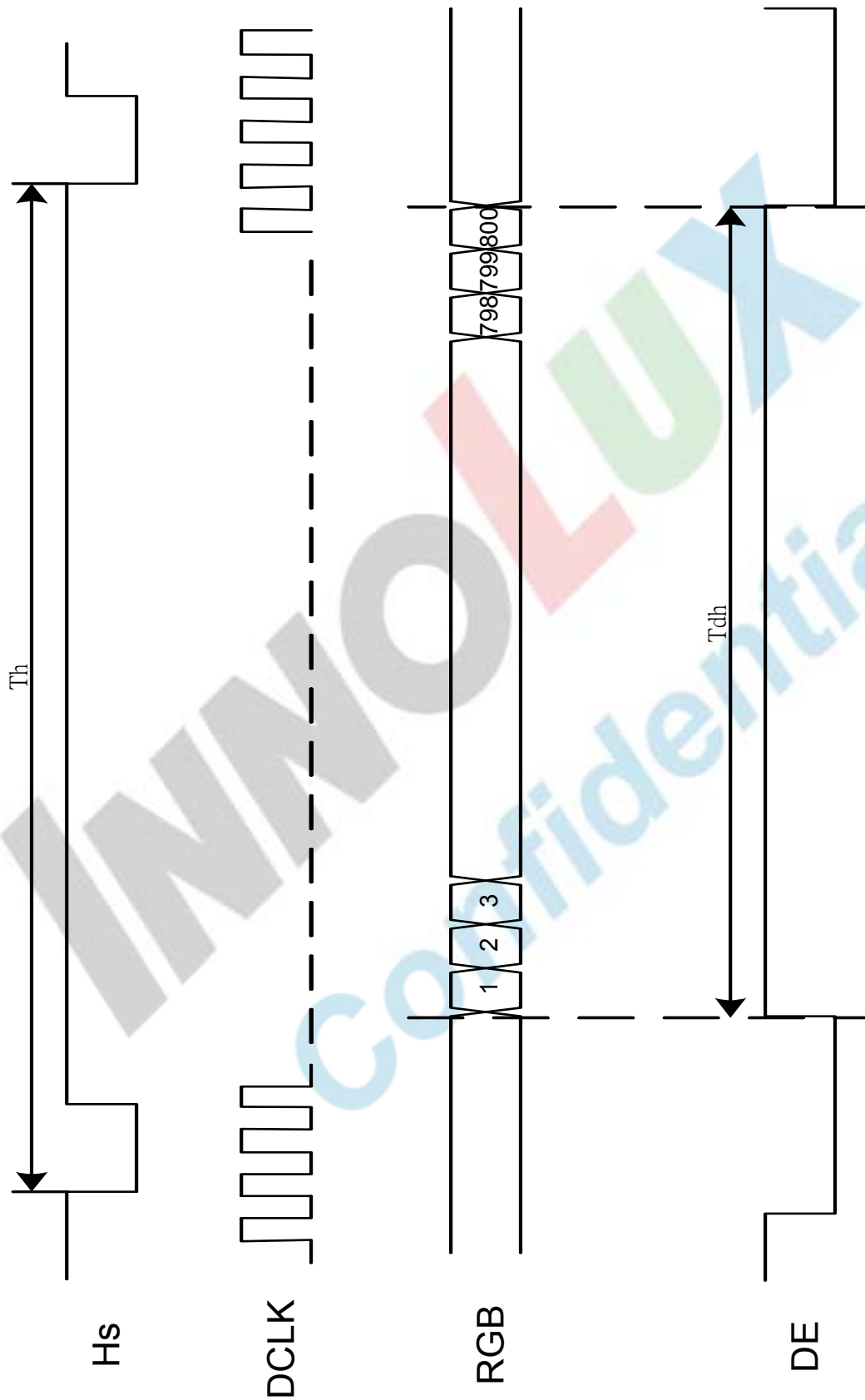

Fig.3-4 Horizontal timing 2

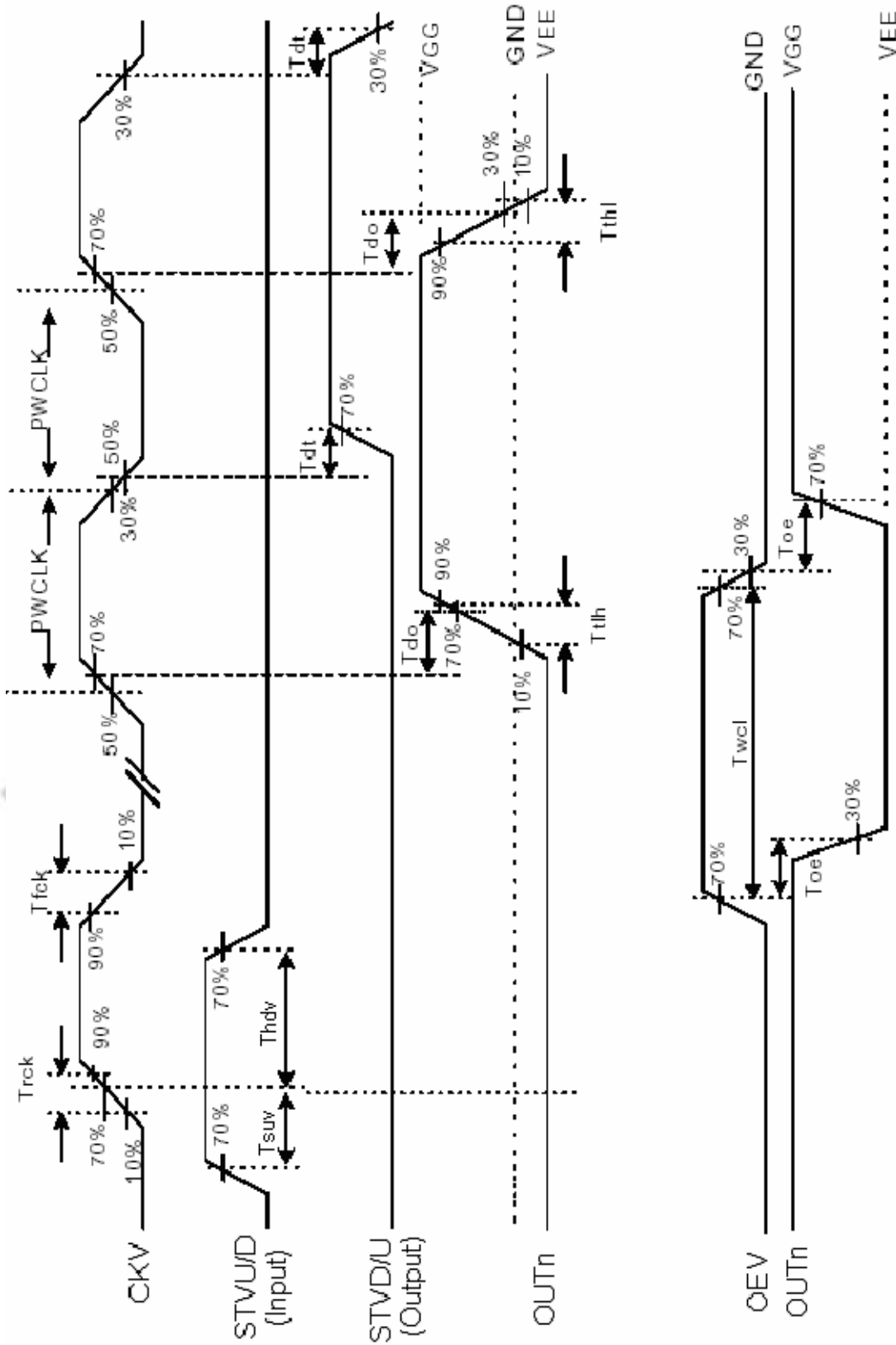

Fig.3-5 Vertical shift clock timing

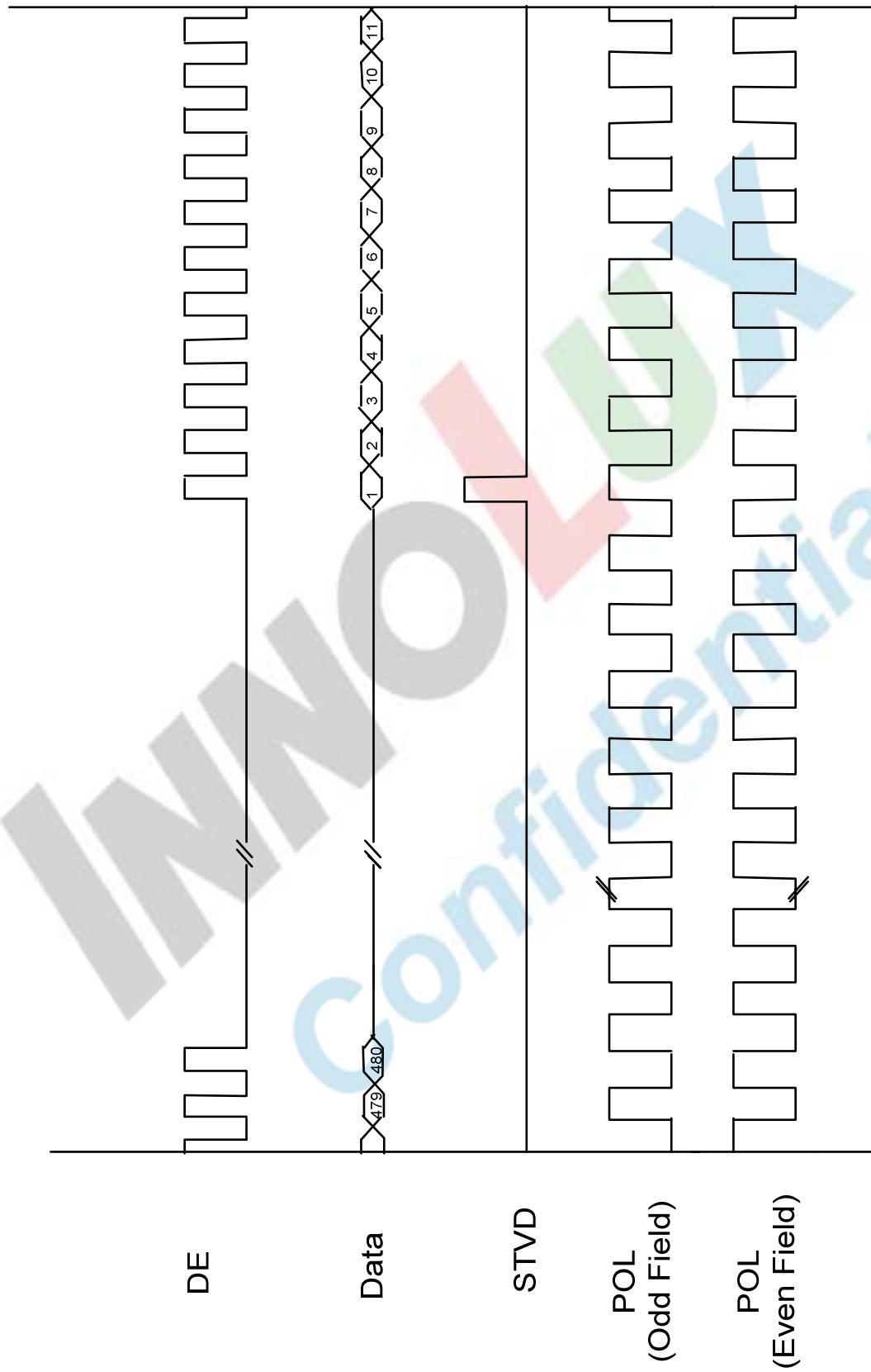

Fig.3-6 Vertical timing (from up to down)

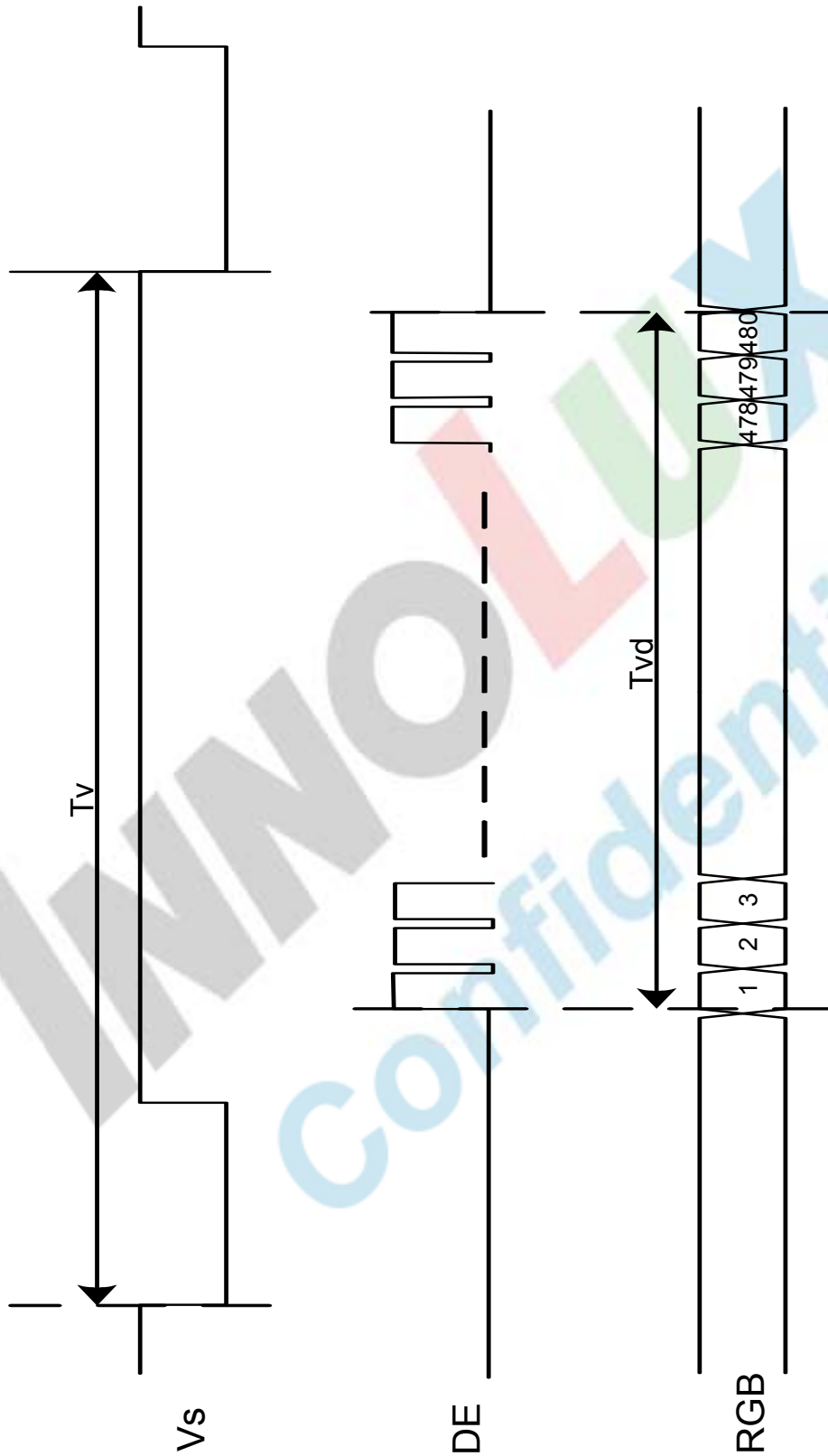

Fig.3-7 Vertical timing

版權屬於群創所有，禁止任何未經授權的使用

The copyright belongs to InnoLux. Any unauthorized use is prohibited.

4. Optical Specifications

| Item | Symbol | Condition | Values | | | Unit | Remark |
|---------------------------|------------|---------------------------------|--------|------|------|-------------------|----------------------------|
| | | | Min. | Typ. | Max. | | |
| Viewing angle (CR≥ 10) | θ_L | $\Phi=180^\circ$ (9 o'clock) | 60 | 70 | - | degree | Note 1 |
| | θ_R | $\Phi=0^\circ$ (3 o'clock) | 60 | 70 | - | | |
| | θ_T | $\Phi=90^\circ$ (12 o'clock) | 40 | 50 | - | | |
| | θ_B | $\Phi=270^\circ$ (6 o'clock) | 60 | 70 | - | | |
| Response time | T_{ON} | Normal $\theta=\Phi=0^\circ$ | - | 10 | 20 | msec | Note 3 |
| | T_{OFF} | | - | 15 | 30 | msec | Note 3 |
| Contrast ratio | CR | | 400 | 500 | - | - | Note 4 |
| Color chromaticity | W_X | | 0.26 | 0.31 | 0.36 | - | Note 2 Note 5 Note 6 |
| | W_Y | | 0.28 | 0.33 | 0.38 | - | |
| Luminance | L | | 360 | 450 | - | cd/m ² | Note 6 |
| Luminance uniformity | Y_U | | 70 | 75 | - | % | Note 7 |

Test Conditions:

1. $DV_{DD} = 3.3V$, $I_L = 180mA$ (Backlight current), the ambient temperature is $25^\circ C$.
2. The test systems refer to Note 2.

Note 1: Definition of viewing angle range

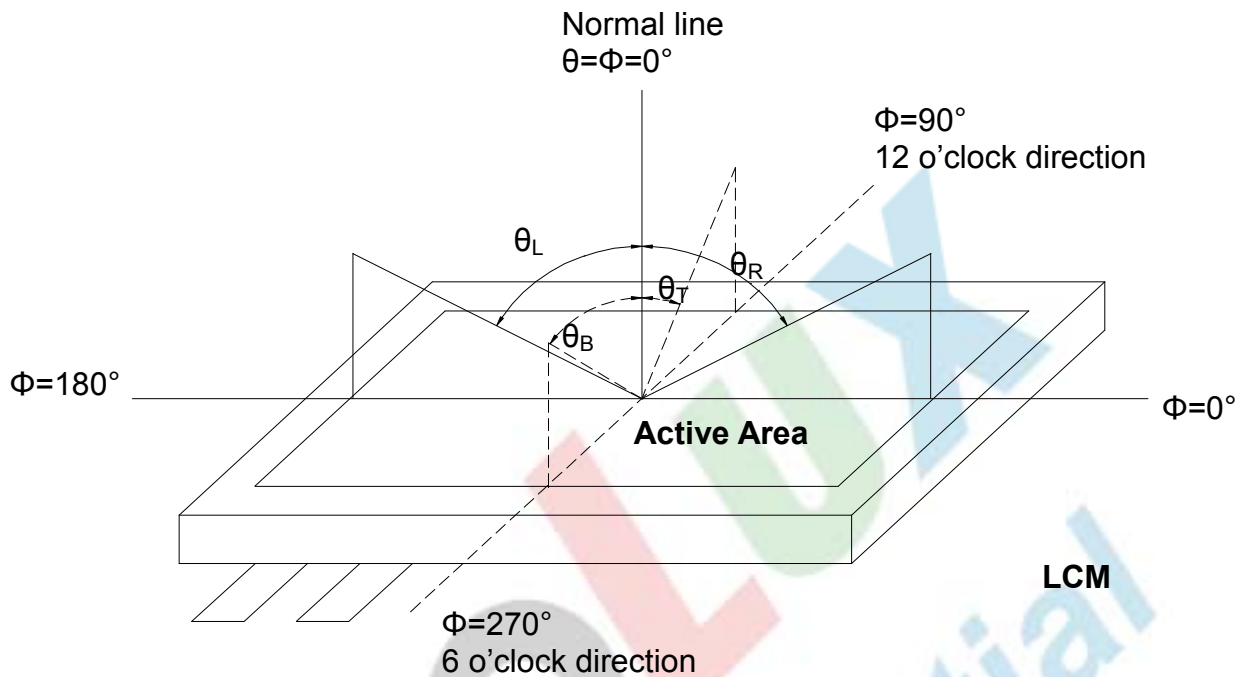

Fig. 4-1 Definition of viewing angle

Note 2: Definition of optical measurement system.

The optical characteristics should be measured in dark room. After 30 minutes operation, the optical properties are measured at the center point of the LCD screen. (Response time is measured by Photo detector TOPCON BM-7, other items are measured by BM-5A/Field of view: 1° /Height: 500mm.)

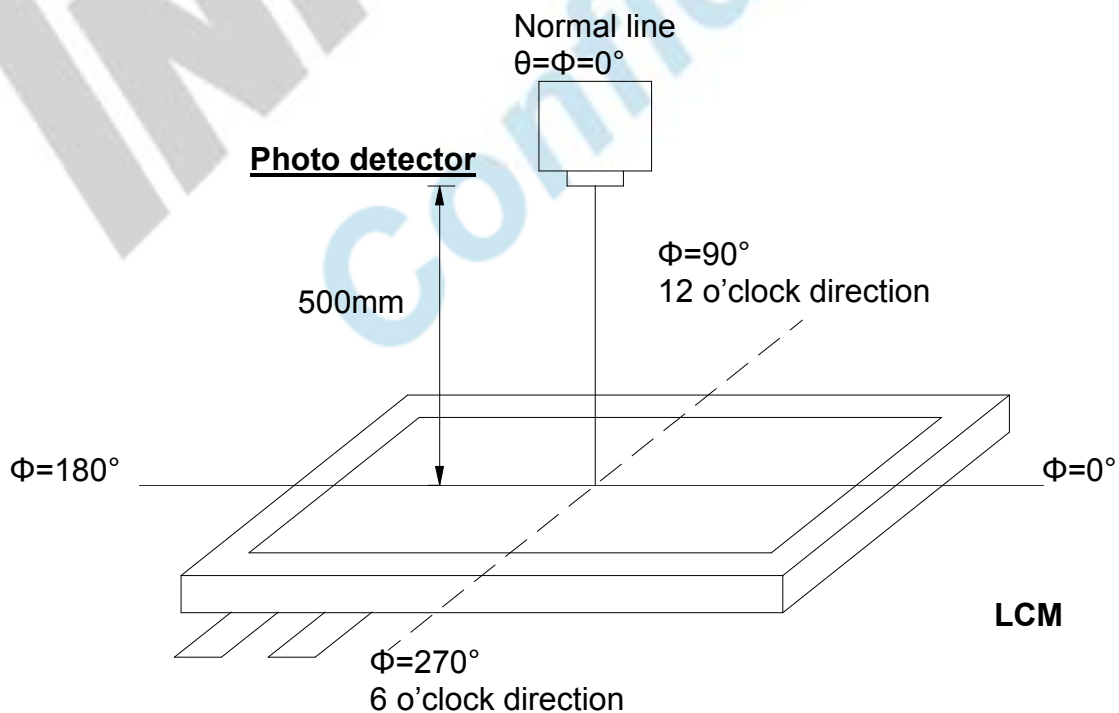

Fig. 4-2 Optical measurement system setup

版權屬於群創所有，禁止任何未經授權的使用

The copyright belongs to InnoLux. Any unauthorized use is prohibited.

Note 3: Definition of Response time

The response time is defined as the LCD optical switching time interval between "White" state and "Black" state. Rise time (T_{ON}) is the time between photo detector output intensity changed from 90% to 10%. And fall time (T_{OFF}) is the time between photo detector output intensity changed from 10% to 90%.

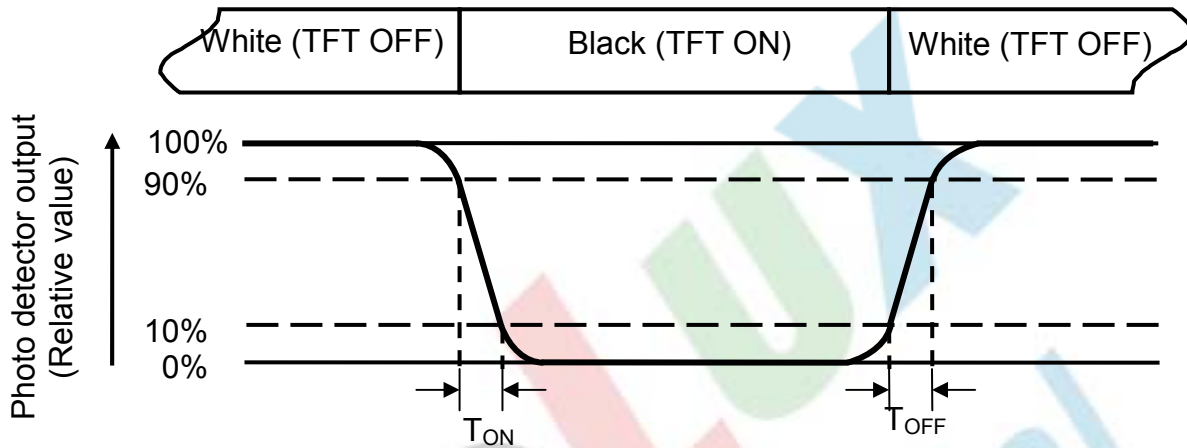

Fig. 4-3 Definition of response time

Note 4: Definition of contrast ratio

$$\text{Contrast ratio (CR)} = \frac{\text{Luminance measured when LCD on the "White" state}}{\text{Luminance measured when LCD on the "Black" state}}$$

Note 5: Definition of color chromaticity (CIE1931)

Color coordinates measured at center point of LCD.

Note 6: All input terminals LCD panel must be ground while measuring the center area of the panel. The LED driving condition is $I_L=180\text{mA}$.

Note 7: Definition of Luminance Uniformity

Active area is divided into 9 measuring areas (Refer to Fig. 4-4).Every measuring point is placed at the center of each measuring area.

$$Luminance\ Uniformity\ (Yu) = \frac{B_{min}}{B_{max}}$$

L-----Active area length W----- Active area width

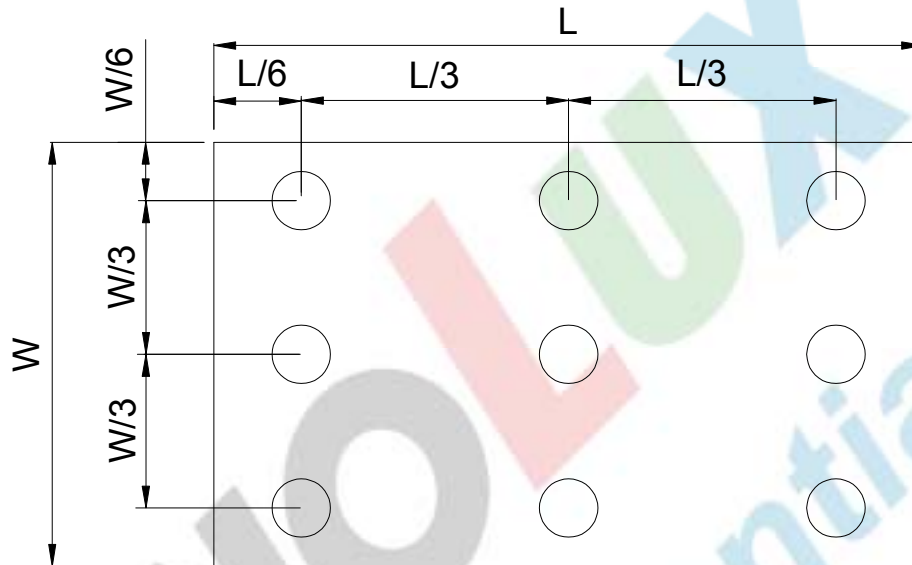

Fig. 4-4 Definition of measuring points

B_{max} : The measured maximum luminance of all measurement position.

B_{min} : The measured minimum luminance of all measurement position.

6. General Precautions

6.1. Safety

Liquid crystal is poisonous. Do not put it in your mouth. If liquid crystal touches your skin or clothes, wash it off immediately by using soap and water.

6.2. Handling

1. The LCD panel is plate glass. Do not subject the panel to mechanical shock or to excessive force on its surface.
2. The polarizer attached to the display is easily damaged. Please handle it carefully to avoid scratch or other damages.
3. To avoid contamination on the display surface, do not touch the module surface with bare hands.
4. Keep a space so that the LCD panels do not touch other components.
5. Put cover board such as acrylic board on the surface of LCD panel to protect panel from damages.
6. Transparent electrodes may be disconnected if you use the LCD panel under environmental conditions where the condensation of dew occurs.
7. Do not leave module in direct sunlight to avoid malfunction of the ICs.

6.3. Static Electricity

1. Be sure to ground module before turning on power or operating module.
2. Do not apply voltage which exceeds the absolute maximum rating value.

6.4. Storage

1. Store the module in a dark room where must keep at $25\pm 10^{\circ}\text{C}$ and 65%RH or less.
2. Do not store the module in surroundings containing organic solvent or corrosive gas.
3. Store the module in an anti-electrostatic container or bag.

6.5. Cleaning

1. Do not wipe the polarizer with dry cloth. It might cause scratch.
2. Only use a soft sloth with IPA to wipe the polarizer, other chemicals might permanent damage to the polarizer.

7. Mechanical Drawing

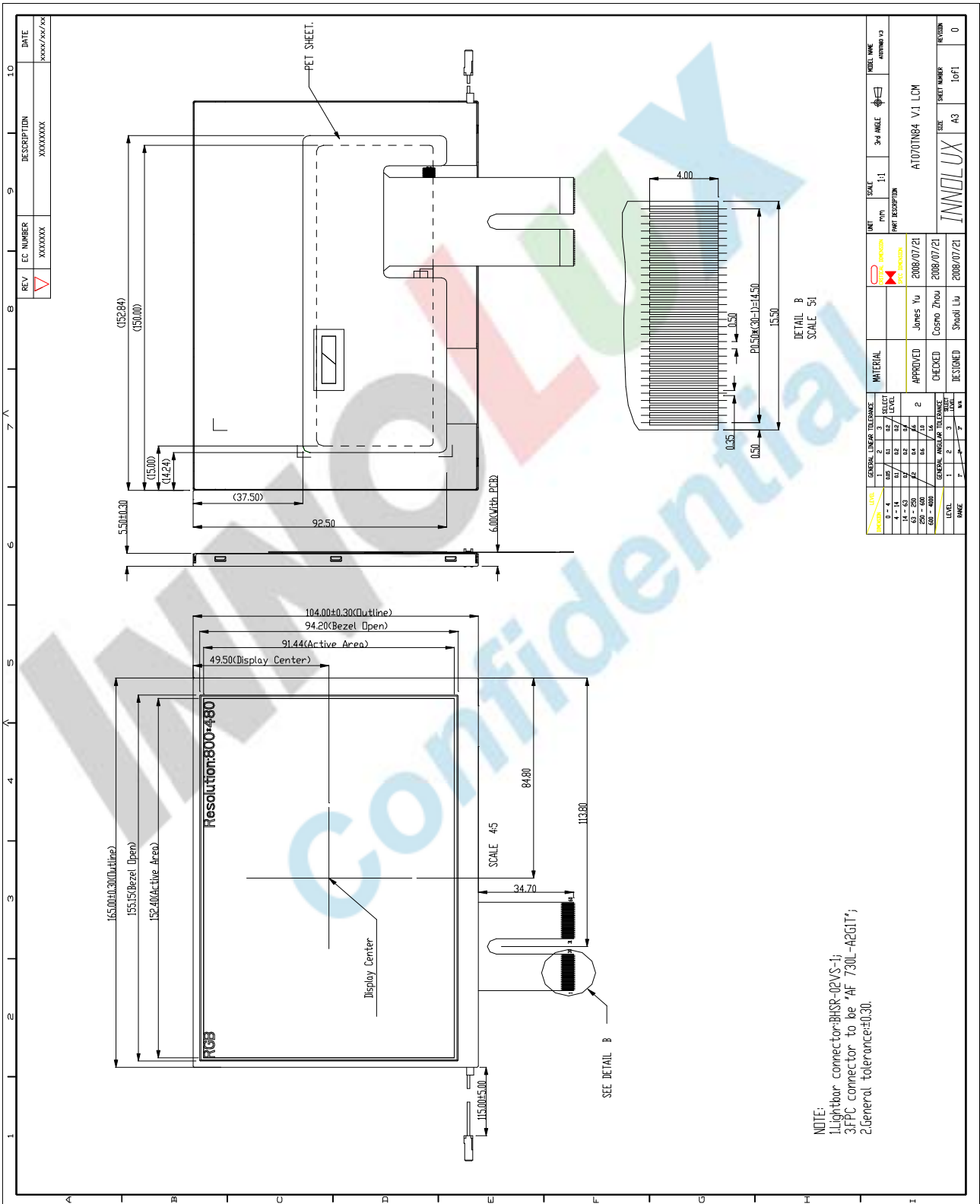

版權屬於群創所有，禁止任何未經授權的使用

8. Package Drawing

8.1. Packaging Material Table

| No. | Item | Model (Material) | Dimensions(mm) | Unit Weight (kg) | Quantity | Remark |
|-----|------------------|---------------------|------------------|------------------|----------|--------|
| 1 | LCM Module | AT070TN84 V.1 | 165 × 104 × 5.5 | TBD | 50pcs | |
| 2 | Partition | BC Corrugated Paper | 512 × 349 × 226 | 1.466 | 1 set | |
| 3 | Corrugated Bar | BC Corrugated Paper | 512 × 162 | 0.046 | 4 set | |
| 4 | Corrugated Board | BC Corrugated Paper | 510 × 343 | 0.130 | 1pcs | |
| 5 | Dust-Proof Bag | PE | 700 × 530 | 0.048 | 1 pcs | |
| 6 | A/S Bag | PE | 180 × 160 × 0.05 | 0.002 | 50 pcs | |
| 7 | Carton | Corrugated paper | 530 × 355 × 255 | 1.100 | 1 pcs | |
| 8 | Total weight | TBD | | | | |

8.2. Packaging Quantity

| | | | | | |
|--|--------|---|------------------|----|------|
| Total LCM quantity in Carton: no. of Partition | 2 Rows | x | quantity per Row | 25 | = 50 |
|--|--------|---|------------------|----|------|

8.3. Packaging Drawing

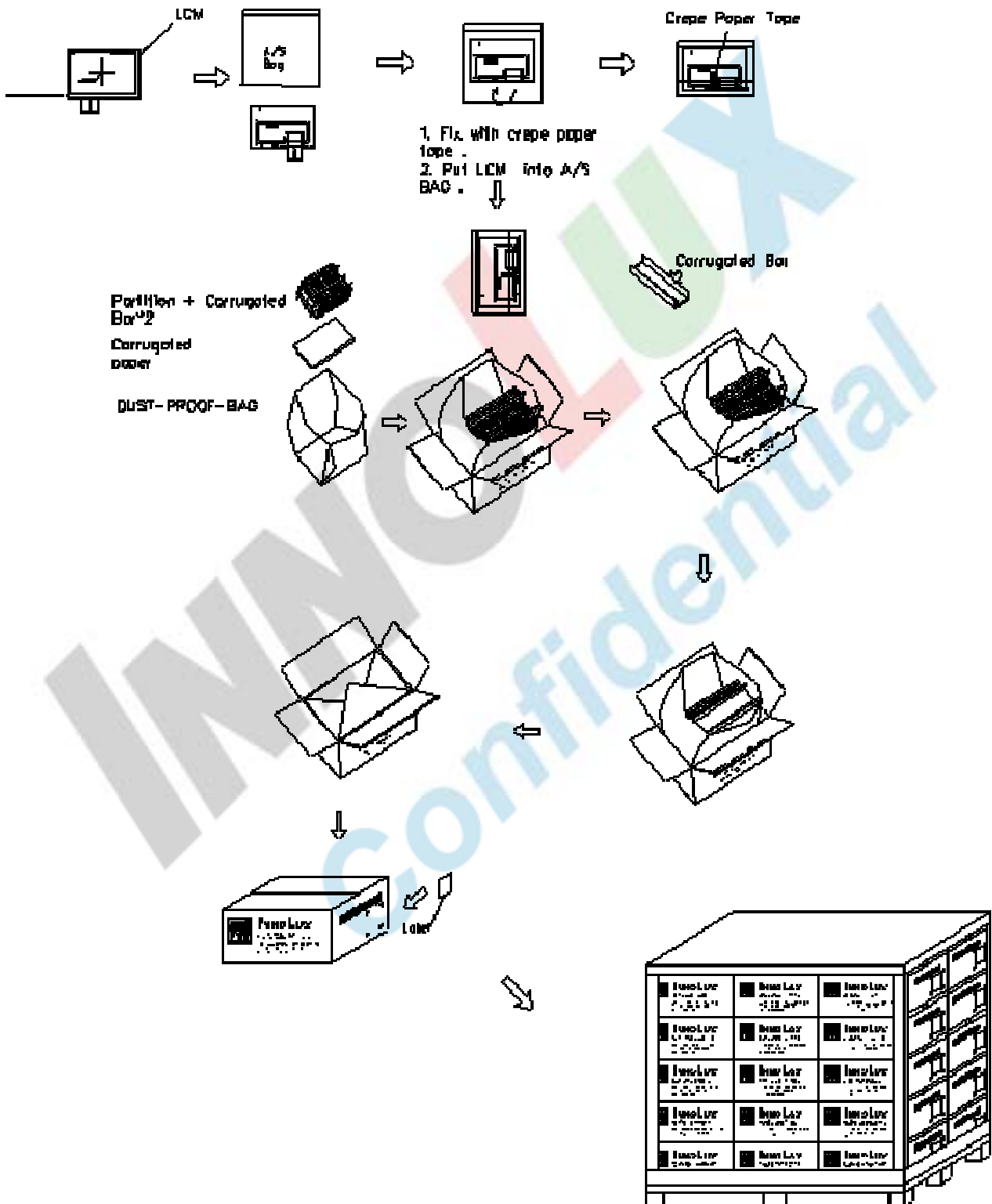

版權屬於群創所有，禁止任何未經授權的使用

The copyright belongs to InnoLux. Any unauthorized use is prohibited.